

Studio Due[®]

emotion and creativity in light



SMART MAX30



SMART I7

Smart RDM
series

RGBWA - MONOCHROMATIC - WHITE BALANCE

User manual
Manuale d'uso

this page is intentionally left blank / questa pagina è stata lasciata intenzionalmente bianca

INDEX

Page 4	Safety informations / Informazioni di sicurezza
Page 5	Introduction / Introduzione
Page 6	Technical features / Caratteristiche tecniche
Page 8	Main supply connection / Collegamento fonte di alimentazione
Page 9	DMX connections / Connessioni DMX
Page 10	Example of connections DMX-Controller / Esempi di collegamento DMX-Controller
Page 11	Setup and configuration (touch control panel) / Configurazione e settaggio (pannello di controllo touch)
Page 14	DMX Channels list / Lista canali DMX
Page 18	Physical / Dimensioni
Page 20	CE standards / Certificazioni CE
Page 22	Warranty / Garanzia

SAFETY INFORMATION (service personnel)

IMPORTANT !

READ ALL CAUTIONS AND WARNINGS PRIOR TO OPERATE THIS EQUIPMENT.

INSTRUCTION TO PREVENT INJURY OR DAMAGE DUE TO ELECTRIC SHOCK, FIRE, MECHANICAL HAZARDS, DANGEROUS MATTERS.

• PROTECTION AGAINST DANGEROUS MATTERS

At the end of its life, must be collected separately. It shouldn't be thrown as urban waste and neither released in the environment.

It must be collected from the nearest special waste collection point or consigned to your dealer that provides the service.

The incorrect waste disposal can damage the environment and the people for the presence of dangerous substances.

Sanctions are provided for an unauthorized disposal.



• PROTECTION AGAINST FIRE

1) Maintain minimum distance of 0,2 meter to lighted objects.

2) Replace fuses (if present) only with the specified type and rating.

3) Do not install the fixture close to heat sources. Do not lay the connection cable on the fixture when it is warm.

4) Fixture designed to be installed on normally flammable surfaces.



• PROTECTION AGAINST ELECTRIC SHOCK

1) This equipment must be earthed.

2) Class I equipment. The power supply cord includes a protective earthing conductor as part of the cord.

3) Disconnect power before servicing (service personnel).

4) To replace the LEDs, contact: Studio Due Trade Srls.

5) If the external flexible cable of this appliance is damaged, it must only be replaced by the manufacturer, its assistance service, or equivalent qualified personnel, in order to avoid dangers.

• PROTECTION AGAINST MECHANICAL HAZARDS

1) Use secondary safety chain when fixing this equipment.

2) The protection screens and the lenses must be replaced with genuine parts only if they are visibly damaged and their effectiveness has been reduced, for example, by cracks or deep scratches.

3) Do not look directly into the illuminated LEDs of the product for long periods of time. LED lamps can cause eye damage or irritation. Do not look directly into the light source using an optical instrument that focuses on the light beams.

The device should be positioned so that there is no prolonged observation of the device at a distance of less than 100cm. (RG1 – IEC/TR 62778:2014).

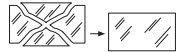

ITA

INFORMAZIONI DI SICUREZZA (personale di servizio)

IMPORTANTE !

LEGGERE ATTENTAMENTE TUTTI GLI AVVERTIMENTI PRIMA DI COMPIERE QUALUNQUE OPERAZIONE SU QUESTO APPARECCHIO.

ISTRUZIONI PER PREVENIRE LESIONI O DANNI DOVUTI AL FUOCO, ALLE SCOSSE ELETTRICHE, AI RISCHI MECCANICI ED A SOSTANZE PERICOLOSE.

• PROTEZIONE CONTRO SOSTANZE PERICOLOSE

A fine vita è oggetto di raccolta separata, non gettare nei comuni cassonetti di rifiuti urbani, né tantomeno nell'ambiente.

Può essere consegnato presso i centri di raccolta delle amministrazioni comunali, oppure presso i rivenditori che forniscono questo servizio.

Lo smaltimento errato può causare danni alle persone e all'ambiente per la possibile presenza di sostanze pericolose.

Sono previste sanzioni in caso di smaltimento abusivo dei suddetti prodotti.



• PROTEZIONE CONTRO IL FUOCO

1) Mantenere la distanza minima di 0,2 metri dagli oggetti illuminati.

2) Sostituire i fusibili (se presenti) solo con altri dello stesso tipo e valore.

3) Non installare il faro vicino fonti di calore. Non appoggiare il cavo di connessione sul faro quando questo è caldo.

4) Questo apparecchio è adatto per il montaggio su superfici normalmente incombustibili.



• PROTEZIONE CONTRO SCOSSE ELETTRICHE

1) Questo apparecchio necessita di messa a terra.

2) Apparecchio di Classe I. Il conduttore di protezione deve far parte del cavo di alimentazione.

3) Disconnettere l'alimentazione prima di aprire l'apparecchio (personale di servizio).

4) Per la sostituzione dei LED contattare l'azienda: Studio Due Trade Srls

5) Se il cavo flessibile esterno di questo apparecchio è danneggiato, deve essere sostituito esclusivamente dal costruttore, dal suo servizio di assistenza, o da personale qualificato equivalente, al fine di evitare pericoli.

• PROTEZIONE CONTRO RISCHI MECCANICI

1) Usare la catena di sicurezza supplementare quando installate l'apparecchio.

2) Gli schermi di protezione e le lenti devono essere sostituiti sempre con ricambi originali se sono visibilmente danneggiati e se la loro efficacia è stata ridotta, per esempio, da fessure o incisioni profonde.

3) Non guardare direttamente nei LED illuminati del prodotto per lunghi periodi di tempo. Le lampade a LED possono causare danni o irritazione agli occhi. Non guardare direttamente nella sorgente luminosa utilizzando uno strumento ottico che si concentra sui fasci di luce. L'apparecchio dovrebbe essere posizionato in modo che non sia prevista un'osservazione prolungata dell'apparecchio ad una distanza inferiore di 100cm. (RG1 – IEC/TR 62778:2014).

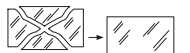

INTRODUCTION

CHECK THAT THE FIXTURE HAS NOT BEEN DAMAGED DURING TRANSPORT. IF IT HAS BEEN DAMAGED OR IT DOES NOT WORK, ADDRESS THE SELLER. WHETHER THE FIXTURE HAS BEEN SHIPPED TO YOU DIRECTLY, PLEASE CONTACT THE SHIPPING COMPANY. ONLY THE CONSIGNEE (PERSON OR COMPANY) CAN CLAIM FOR THESE DAMAGES.

Thank you for choosing one of the SMART RDM series appliances, our small and compact IP67 FLOOD LIGHT projector. Suitable for permanent architectural installations, is flexible for mounting on poles, walls or on the ground.

RDM control and configuration. Integral Wireless DMX control is available as an option (art. WI PCB-REC).

- Standard fixture colour finishing is grey.

- Art. 2001 SMART17 RDM RGBWA
- Art. 2002 SMART17 RDM M (monochromatic)
- Art. 20021 SMART17 M PLUG-IN (monochromatic)
- Art. 20022 SMART17 RDM WB (white balance)
- Art. 2050 SMART MAX30 RDM RGBWA
- Art. 2053 SMART MAX30 RDM M (monochromatic)
- Art. 20531 SMART MAX30 M PLUG-IN (monochromatic)
- Art. 2052 SMART MAX30 RDM WB (white balance)

To obtain the best performances and for a correct functioning of this unit for the years to come, we suggest you to read carefully this manual before connecting or putting the fixture into use. By doing so you will gain experience with its commands and connections and you will be easily able to use it.

YOUR REFERENCE

Always remember to give the serial number and to specify the model any time you address the seller for information or assistance.

BASIC KIT

- Fixture
- Main power 1.5mt 3x1 cable
- IN-OUT DMX 3pins IP67 connectors
- User manual
- Studio Due warranty
- CE standards

OPTIONAL ACCESSORIES

- Barn-door
- Wireless DMX receiver

INTRODUZIONE

CONTROLLATE CHE L'APPARECCHIO NON ABBA SUBITO ALCUN DANNO DURANTE IL TRASPORTO. SE AVESSE SUBITO DEI DANNI O SE NON DOVESSE FUNZIONARE, RIVOLGETEVI AL VOSTRO RIVENDITORE. SE L'APPARECCHIO VI È STATO SPEDITO DIRETTAMENTE, RIVOLGETEVI SUBITO ALLA DITTA DI TRASPORTO.

SOLO IL DESTINATARIO (LA PERSONA O DITTA RICEVENTE L'APPARECCHIO) PUÒ RECLAMARE PER QUESTO TIPO DI DANNI.

Grazie per aver scelto uno degli apparecchi della serie SMART RDM, il nostro piccolo e compatto proiettore IP67 FLOOD LIGHT. Adatto per installazioni architettoniche permanenti, è ideale per il montaggio su pali, pareti o sul terreno.

Controllo e configurazione RDM. Il controllo DMX wireless integrato è disponibile come opzione (art. WI PCB-REC).

- Finitura standard colore grigio.

- Art. 2001 SMART17 RDM RGBWA
- Art. 2002 SMART17 RDM M (monocromatico)
- Art. 20021 SMART17 M PLUG-IN (monocromatico)
- Art. 20022 SMART17 RDM WB (white balance)
- Art. 2050 SMART MAX30 RDM RGBWA
- Art. 2053 SMART MAX30 RDM M (monocromatico)
- Art. 20531 SMART MAX30 M PLUG-IN (monocromatico)
- Art. 2052 SMART MAX30 RDM WB (white balance)

Per ottenere il meglio delle prestazioni ed un corretto funzionamento negli anni di questa unità, Vi consigliamo di leggere attentamente questo manuale prima di collegarla e metterla in uso. In questo modo acquisirete familiarità con i suoi comandi e collegamenti affinché possiate utilizzarla facilmente.

VOSTRA REFERENZA

Citate sempre il numero del modello e di serie ogni volta che Vi rivolgete al vostro rivenditore per informazioni o assistenza.

CONFEZIONE BASE

- Apparecchio
- Cavo di rete 1.5mt 3x1
- Connettori IN-OUT DMX 3pins IP67
- Manuale d'uso
- Garanzia Studio Due
- Dichiarazione CE

ACCESSORI OPZIONALI

- Barn-door
- Ricevitore Wireless DMX

SMART 17 TECHNICAL FEATURES / CARATTERISTICHE TECNICHE SMART 17



ITEM	RGBWA [KEY features] SMART 17
LEDs	13 RGB-NW (White 4000K) + 4 PC-Amber (NICHIA hi-power LEDs)
Total light power	33W
Lumen	R 520, G 850, B 300, W 800, A 500
Optics	24° (23mm lenses) PMMA 8N On request: 12°, 36°, 10°x30°, 15°x55°
Tilt	175° manual
Connections	Main IN: 1.5mt 3x1 cable with bare ends DMX: IN-OUT 3pins IP67 connectors
Control	Standard interface: RS-485 Protocol: USITT DMX512 / RDM > Available as accessories: Wireless DMX receiver
Setup and Configuration	RDM control/configuration or by DRS (remote control device) Dedicated DMX channel for white balance DMX or Auto mode with Master-Slave function Intelligent temperature control Halogen simulation CYM simulation Flicker-free function Smooth dimming function
Power supply	Universal 100/240VAC, 47-63Hz Active PFC: >0.9@230V
Current	0,16A@230Vac
Power	36W
DMX channels	10CH mode, 7CH mode, 6CH mode, 5CH mode
Physical	175x95x215 mm
Weight	2,2 Kg
Material	Housing in die-cast aluminium - bracket in stainless steel - ultra clear white 4mm tempered glass



ITEM	FIXTURE	[KEY features]
LEDs	Monochromatic	17 NICHIA-NVSL219C 4000K available 2700K, 5000K, 6500K On request: red, green, blue or amber
	White Balance	9 warm white (2700K) + 8 cool white (6500K) NICHIA-NVSL219C
Total light power		28W
Lumen	Monochromatic	3000lm @4000K
	White Balance	2500lm @4000K
Optics		24° (23mm lenses) PMMA 8N - On request: 12°, 36°, 10°x30°, 15°x55°
Tilt		270° manual
Connections		IN-OUT DMX 3pins IP67 connectors (none for Plug-in version) - 1.5mt 3x1 cable. with bare ends
Control - Setup		DMX 512 / RDM - RDM / DRS Dedicated DMX channel for white balance DMX or Auto mode with Master-Slave function Halogen simulation Flicker-free function Smooth dimming function
Power consumption		32W - 0,12A@230V
Voltage range		Universal 100/240VAC, 47-63Hz, Active PFC: >0.9@230V
DMX channels		Monochromatic : 3CH mode, 1CH mode (none for Plug-in version) White Balance: 4CH mode, 2CH mode, 1CH mode
Physical		175x95x215 mm
Weight		2,2 Kg
Material		Housing in die-cast aluminium - bracket in stainless steel - ultra clear white 4mm tempered glass

SMART MAX30 TECHNICAL FEATURES / CARATTERISTICHE TECNICHE SMART MAX30



ITEM	RGBWA [KEY features] SMART MAX30
LEDs	24 RGB-NW (White 4000K) + 6 PC-Amber (NICHIA hi-power LEDs)
Total light power	59W
Lumen	R 960lm, G 1570lm, B 550lm, W 1479lm, A 850lm
Optics	24° (23mm lenses) PMMA 8N On request: 12°, 36°, 10°x30°, 15°x55°
Tilt	175° manual
Connections	Main IN: 1.5mt 3x1 cable with bare ends DMX: IN-OUT 3pins IP67 connectors
Control	Standard interface: RS-485 Protocol: USITT DMX512 / RDM > Available as accessories: Wireless DMX receiver
Setup and Configuration	RDM control/configuration or by DRS (remote control device) Dedicated DMX channel for white balance DMX or Auto mode with Master-Slave function Intelligent temperature control Halogen simulation CYM simulation Flicker-free function Smooth dimming function
Power supply	Universal 100/240VAC, 47-63Hz Active PFC: >0.9@230V
Current	0,28A@230Vac
Power	65W
DMX channels	10CH mode, 7CH mode, 6CH mode, 5CH mode
Physical	205x110x235 mm
Weight	3,2 Kg
Material	Housing in die-cast aluminium - bracket in stainless steel - ultra clear white 4mm tempered glass

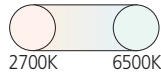

ITEM	FIXTURE	[KEY features] SMART MAX30
LEDs	Monochromatic	30 NICHIA-NVSL219C 4000K available 2700K, 5000K, 6500K On request: red, green, blue or amber
	White Balance	15 warm white (2700K) + 15 cool white (6500K) NICHIA-NVSL219C
Total light power		40W
Lumen	Monochromatic	5000lm @4000K
	White Balance	4500lm @4000K
Optics		24° (23mm lenses) PMMA 8N - On request: 12°, 36°, 10°x30°, 15°x55°
Tilt		175° manual
Connections		IN-OUT DMX 3pins IP67 connectors (none for Plug-in version) - 1.5mt 3x1 cable with bare ends
Control - Setup		DMX 512 / RDM - RDM / DRS Dedicated DMX channel for white balance DMX or Auto mode with Master-Slave function Halogen simulation Flicker-free function Smooth dimming function
Power consumption		44W - 0,2A@230V
Voltage range		Universal 100/240VAC, 47-63Hz, Active PFC: >0.9@230V
DMX channels		Monochromatic : 3CH mode, 1CH mode - White Balance: 4CH mode, 2CH mode, 1CH mode (none for Plug-in version)
Physical		205x110x235 mm
Weight		3,2 Kg
Material		Housing in die-cast aluminium - bracket in stainless steel - ultra clear white 4mm tempered glass

CONNECTION TO THE MAIN POWER / CONNESSIONE ALLA RETE ELETTRICA

This equipment must be earthed.

Class I equipment. The power supply cord includes a protective earthing conductor as part of the cord.

IMPORTANT: to ensure the protection rating of the fixture, in case of replacement of the conductor cable, refer to the CONDUCTOR SIZE TABLE

Questo apparecchio necessita di messa a terra.

Apparecchio di Classe I. Il conduttore di protezione deve far parte del cavo di alimentazione.

IMPORTANTE: per garantire il grado di protezione dell'apparecchio, in caso di sostituzione del cavo di alimentazione, fare riferimento alla TABELLA SEZIONE CONDUTTORE.

ATTENTION - HIGH VOLTAGE!

ALWAYS DISCONNECT THE MAINS SUPPLY BEFORE ACCESS TO THE CONNECTION AREA.

ATTENZIONE - ALTA TENSIONE!

SCOLLEGARE SEMPRE L'ALIMENTAZIONE PRIMA DI APRIRE IL VANO DEI COLLEGAMENTI.

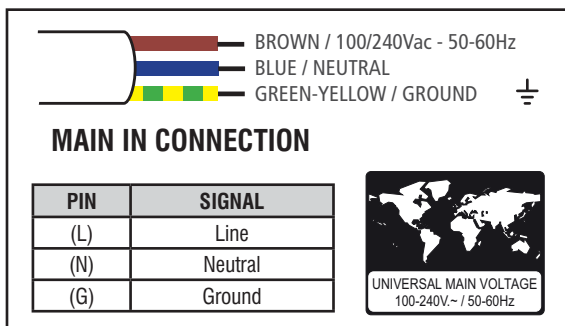

**POWER INPUT/
INGRESSO ALIMENTAZIONE \varnothing 6 - 12mm**

CONDUCTOR SIZES / SEZIONE CONDUTTORE (length / lunghezza < 20mt.)	
MAINS VOLTAGE	CROSS SELECTIONAL AREAS
230V	3X1 mm ² (minimum)

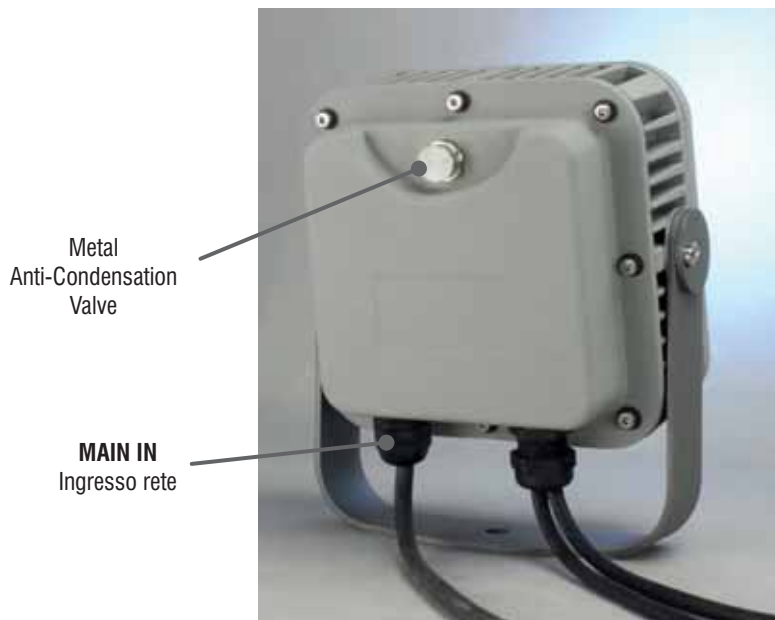

CONNECTION TO THE DMX SIGNAL / CONNESSIONE AL SEGNALE DMX

DMX TERMINAL LINE

The wrong connection of the terminal line or its non-connection are probably the most frequent reasons of the lower DMX signal.

The terminator is a terminal resistor fitted at the end of the cable. (see pict. 1)

The terminal resistor should have the same value as the impedance of the connection cable (120 Ohm).

It is recommended that all DMX 512 systems have the terminal resistor fitted in the end of DMX line.

TERMINALE LINEA DMX

L'incorretto o il mancato collegamento del terminale di linea è probabilmente la più comune causa del difettoso funzionamento della linea DMX.

Il terminale di linea DMX consiste in una resistenza posta alla fine della linea. (vedere fig. 1)

La resistenza terminale dovrebbe avere lo stesso valore dell'impedenza del cavo di collegamento (120 Ohm).

E' raccomandato per tutti i sistemi DMX 512, di inserire il terminale di linea nel connettore di uscita DMX dell'ultimo apparecchio collegato.

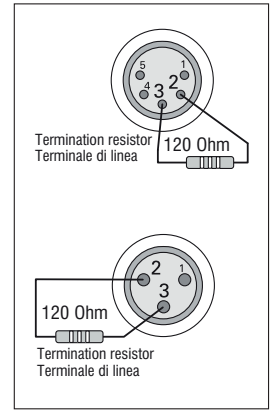

pict. 1



DMX IN/OUT



ø 14mm
Female connector



ø 14mm
Male connector

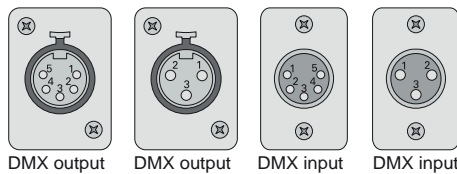

DMX output DMX output DMX input DMX input

PIN		
1	SHIELD	GROUND/RETURN/OV
2	INNER CONDUCTOR	DATA COMPLEMENT (-, INVERTED)
3	INNER CONDUCTOR	DATA TRUE (+, NON INVERTED)

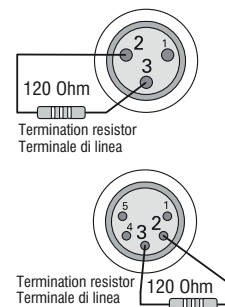

EXAMPLE OF CONNECTION DMX CONTROLLER - FIXTURES / ESEMPIO DI COLLEGAMENTO CENTRALINA - FARI

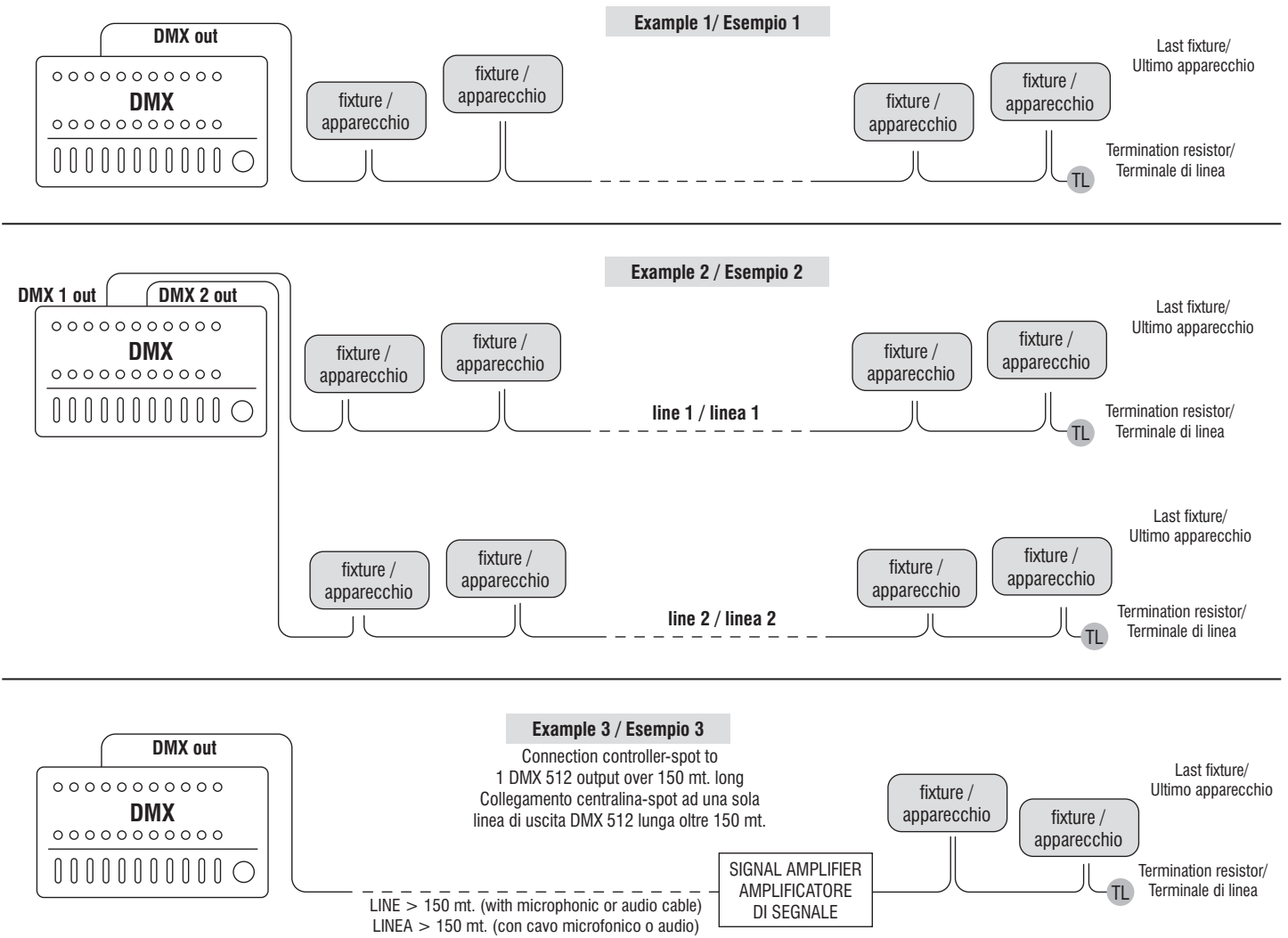

NORMAL AND MASTER/SLAVE FUNCTIONS / FUNZIONI NORMAL E MASTER/SLAVE

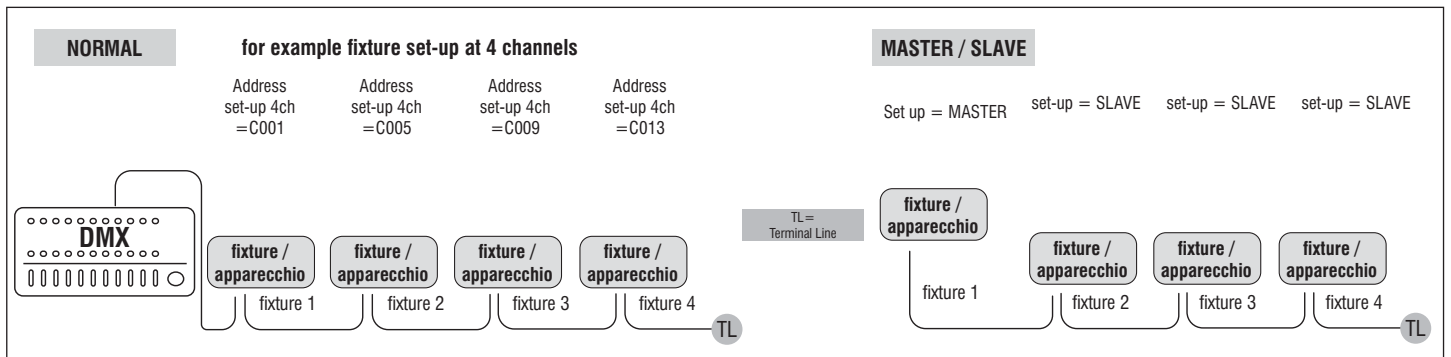

SETUP AND CONFIGURATION BY DRS - DMX REMOTE SETUP

The DRS it's a new concept of professional LED Lighting fixtures suitable for outdoor permanent installations. The LED Lighting fixtures can be driven via DMX through a specific electronic device, the DRS DMX Remote Setup, that grant the possibility to set up the scenarios and the games remotely. These LED Lighting fixtures have installed on board a series of programs including the stand alone function.

The DRS is a simple set up commander that linked with the DMX input of a LED Lighting fixture allow to program all the functions of the luminaire. It's than possible to assign the DMX channel or use the Master/Slave function. The device is powered through battery.

SETTAGGIO E CONFIGURAZIONE TRAMITE DRS - DMX REMOTE SETUP

DRS è il nuovo concetto dell'illuminazione LED per uso professionale nelle installazioni esterne permanenti. Gli apparecchi LED possono essere controllati e configurati tramite uno specifico controller: il DRS, DMX Remote Setup, il quale consente di programmare e configurare scene e giochi di luce in modalità remota. Questi apparecchi LED hanno installati a bordo una serie di giochi che includono la funzione stand alone.

Il DRS, DMX Remote Setup, è un semplice set-up commander che collegato via DMX ad un'apparecchio consente la sua programmazione e configurazione. E' possibile assegnare agli apparecchi collegati i canali DMX o utilizzare la funzione Master/Slave. Il DRS è alimentato a batterie.

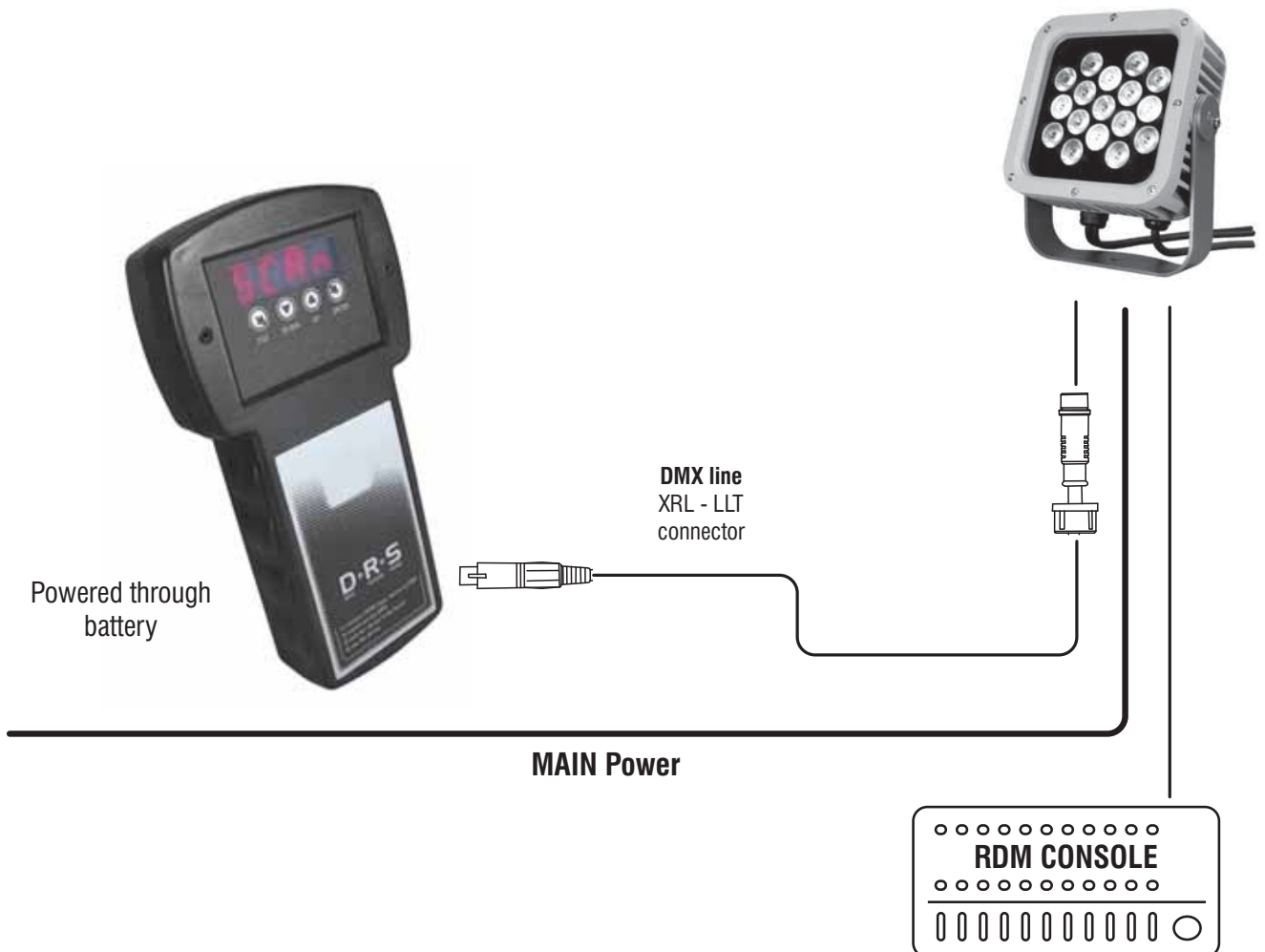

SETUP AND CONFIGURATION BY DRS - DMX REMOTE SETUP

dimmable version only / solo versione dimmerabile

To make the set-up of the various fixture parameter, proceed as follow:

- Disconnect the fixture to set-up from the other DMX/RDM devices

- Connect the DMX cable of the fixture to the DRS commander

-  Switch on the DRS commander and wait for the **8888** sign

-  If the DRS commander detects a compatible DRS device, displays shortly the **Conn** written and afterwards, displays the name of the fixture and its software version.

-  If the DRS commander don't detects any compatible DRS device or is present any malfunction, the display shows the **SCAn** written

-  When the detection sequence is finished, the display shows the first menu

-  The UP/DOWN buttons allow to scroll forward/backward the menu list

-  The ENTER button allow to confirm the selected option (if the parameter is flashing)

-  The ESC button allow to delete the operation and return to a previous menu level

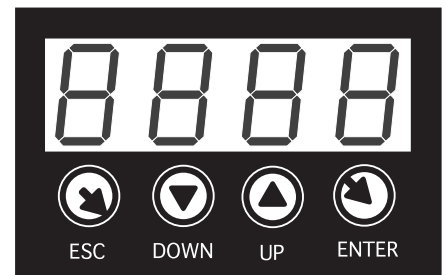

SETTAGGIO E CONFIGURAZIONE TRAMITE DRS - DMX REMOTE SETUP

Per effettuare la programmazione dei vari parametri di un apparecchio, è necessario procedere come segue:

- Disconnettere l'apparecchio da configurare da altri dispositivi DMX/RDM

- Collegare il cavo DMX dell'apparecchio da configurare, al programmatore DRS

-  Accendere il programmatore DRS ed attendere che visualizzi la scritta **8888**

-  Se il programmatore DRS individua un dispositivo DRS compatibile, visualizza per qualche istante la scritta **Conn** e, successivamente, visualizza il nome dell'apparecchio e la relativa versione software

-  Se il programmatore DRS non individua alcun dispositivo DRS compatibile o è presente qualche malfunzionamento il display visualizzerà la scritta **SCAn**

-  Una volta terminata la sequenza di riconoscimento, viene visualizzato il primo menu dell'apparecchio

-  I pulsanti UP/DOWN permettono di scorrere la lista dei menu













-  Il pulsante ENTER permettere di entrare in un menu o di confermare una opzione in caso di lampeggio del parametro

-  Il pulsante ESC annulla una operazione o torna al livello di menu inferiore.

DRS MENU' LIST / ELENCO MENU DRS

Switching on the fixture you can see the model and the software version. For example:
All'accensione, viene visualizzato il modello di apparecchio e la versione software. Per esempio:

--> MP-240 --> 1_00 - than it's shown the fist menu / poi viene visualizzato il primo menu

Address (Addr)		Set the DMX channel address / Imposta il canale DMX > Select the channel number .. c001 .. c002 .. whit the UP/DOWN buttons. Press ENTER. > Selezionate il canale desiderato .. c001 .. c002 .. con i tasti UP/DOWN. Premere ENTER.
Auto Mode (ModE)		Set the DMX, SLAVE or MASTER mode / Imposta la modalità DMX, SLAVE o MASTER > Select the value no .. sl .. pr01 .. pr02 .. with the UP/DOWN buttons. Press ENTER. > Selezionate il valore desiderato no .. sl .. pr01 .. pr02 .. con i tasti UP/DOWN. Premere ENTER.
Auto Speed (PrSP)		Set the preset execution speed / Imposta la velocità di esecuzione dei giochi interni > Select the value +400% .. -400% with the UP/DOWN buttons. Press ENTER. > Selezionate il valore desiderato +400% .. -400% con i tasti UP/DOWN. Premere ENTER.
N. Channels (nChn)		Set the DMX channels of the fixture / Imposta il numero di canali DMX dell'apparecchio. (10, 7, 6, 5) > Select the value, e.g. .. 7 .. 5 etc. with the UP/DOWN buttons. Press ENTER. > Selezionate il valore desiderato, per esempio .. 7 .. 5 etc. con i tasti UP/DOWN. Premere ENTER.
Wireless enable (ULEn)		Enable or disable the wireless reception / Consente o non consente la ricezione wireless. (ON, OFF) The cable reception is disabled / La ricezione via cavo viene disabilita > Select the value on .. off .. with the UP/DOWN buttons. The written is flashing, press ENTER. > Selezionate il valore desiderato on .. off .. con i tasti UP/DOWN. La scritta lampeggia, premere ENTER.
Wireless unlink (ULPA)		Remove the link from the fixture to the associated transmitter (PA?). Press ENTER. Elimina il link tra l'apparecchio e il trasmettitore al quale è stato associato. Premere ENTER.
Wireless bridge (ULbr)		If wireless is ON, enable the transmission of the received data by cable to the other fixtures Se il wireless è attivo, consente la trasmissione dati agli altri apparecchi collegati via cavo. (ON, OFF) > Select the value on .. off .. with the UP/DOWN buttons. Press ENTER. > Selezionate il valore desiderato on .. off .. con i tasti UP/DOWN. Premere ENTER.
Smooth Dimming (SMth)		Set the interpolation type for the smooth dimming function Imposta il tipo di interpolazione per la funzione smooth dimming. (OFF, Sd1, Sd2, Sd3) > Select the value off .. LoW .. Mld .. hIGH with the UP/DOWN buttons. Press ENTER. > Selezionate il valore desiderato off .. LoW .. Mld .. hIGH con i tasti UP/DOWN. Premere ENTER.
Halogen Simulation (HALS)		Set the alogen simulation function mode Imposta il funzionamento della modalità simulazione lampada alogena. (OFF, Mod1, Mod2) > Select the value off .. Mld1 .. Mld2 with the UP/DOWN buttons. Press ENTER. > Selezionate il valore desiderato off .. Mld1 .. Mld2 con i tasti UP/DOWN. Premere ENTER.
CYM Emulation (CYMS)		Set the fixture to work in CYM or RGB emulation system Imposta l'apparecchio per funzionare come emulatore di sistema CYM o RGB. (CYM, RGB) > Select the value off >> RGB or on >> CYM with the UP/DOWN buttons. Press ENTER. > Selezionate il valore desiderato off >> RGB oppure on >> CYM con i tasti UP/DOWN. Premere ENTER.
Flicker free function (FLcr)		Flicker free function / Funzione flicker free. (F1, F2) > Select the value f1 .. f2 > Selezionate il valore desiderato f1 .. f2
Test (tEst)		Enables the test of the fixture and execute a factory program to check the right functioning/ Abilita il test dell'apparecchio ed esegue un programma di fabbrica per verificarne il funzionamento. (T-ON) > Select the value t-on with the UP/DOWN buttons. T-on is flashing: test in progress. Press any key to exit. > Selezionate il valore t-on con i tasti UP/DOWN. T-on lampeggia: test in corso. Premere qualsiasi tasto per uscire.

Reset (rSet)



Execute a reset of the electronic section / Eseguo un reset della parte elettronica. (rS?)

Format (FrMt)



Restore the factory setting (Require confirmation).
Ripristina le impostazioni di fabbrica (Viene chiesta conferma). (Fr?)







DMX Channels list 10Ch / Lista dei canali DMX 10Ch

8 BIT	FUNCTION	0 31 63 95 127 159 191 233 255
CH1	RED	
CH2	GREEN	
CH3	BLUE	
CH4	WHITE	
CH5	AMBER	
CH6	DIMMER	
CH7	STROBE	
CH8	LED FADE TIME	
CH9	RAINBOW	
CH10	BALANCED WHITE	





DMX Channels list 7Ch / Lista dei canali DMX 7Ch

8 BIT	FUNCTION	0 31 63 95 127 159 191 233 255
CH1	RED	
CH2	GREEN	
CH3	BLUE	
CH4	WHITE	
CH5	AMBER	
CH6	DIMMER	
CH7	RAINBOW	

DMX Channels list 6Ch / Lista dei canali DMX 6Ch

8 BIT	FUNCTION	0 31 63 95 127 159 191 233 255
CH1	RED	
CH2	GREEN	
CH3	BLUE	
CH4	WHITE	
CH5	AMBER	
CH6	DIMMER	

DMX Channels list 5Ch / Lista dei canali DMX 5Ch

8 BIT	FUNCTION	0 31 63 95 127 159 191 233 255
CH1	RED	
CH2	GREEN	
CH3	BLUE	
CH4	WHITE	
CH5	AMBER	

DMX CHANNELS and DALI LINE / CANALI DMX e LINEA DALI

- (*) DMX line for Dimmable version. (setting 3ch or 1ch)

- (*) linea DMX versione Dimmerabile. (settaggio 3ch o 1ch)

DMX 512	8 BIT	FUNCTION	0 31 63 95 127 159 191 233 255
	CH1	DIMMER	
	CH2	STROBE	
	CH3	LED FADE TIME	
DMX 512	8 BIT	FUNCTION	0 31 63 95 127 159 191 233 255
	CH1	DIMMER	

OPTIONAL CONNECTION TO DALI / CONNESSIONE OPZIONALE ALLA LINEA DALI

- (**) DALI line refer to next page to see the connection **.

- (**) linea DALI fare riferimento alla pagina seguente per i collegamenti **.

OPTIONAL CONNECTION TO DMX LINE / CONNESSIONE OPZIONALE ALLA LINEA DMX

- (*) DMX line for Dimmable version. (setting 3ch or 1ch)

- (*) linea DMX versione Dimmerabile. (settaggio 3ch o 1ch)

DMX 512	8 BIT	FUNCTION	0 31 63 95 127 159 191 233 255
	CH1	DIMMER	
	CH2	STROBE	
	CH3	LED FADE TIME	
DMX 512	8 BIT	FUNCTION	0 31 63 95 127 159 191 233 255
	CH1	DIMMER	

DMX CHANNELS for WHITE BALANCE / CANALI DMX per WHITE BALANCE

- **DMX line** (setting 4ch, 2ch or 1ch)

- **linea DMX** (settaggio 4ch, 2ch o 1ch)

DMX 512

8 BIT	FUNCTION	0 31 63 95 127 159 191 233 255
CH1	BALANCED WHITE	
CH2	DIMMER	
CH3	STROBE	
CH4	LED FADE TIME	

DMX 512

8 BIT	FUNCTION	0 31 63 95 127 159 191 233 255
CH1	BALANCED WHITE	
CH2	DIMMER	

DMX 512

8 BIT	FUNCTION	0 31 63 95 127 159 191 233 255
CH1	BALANCED WHITE	

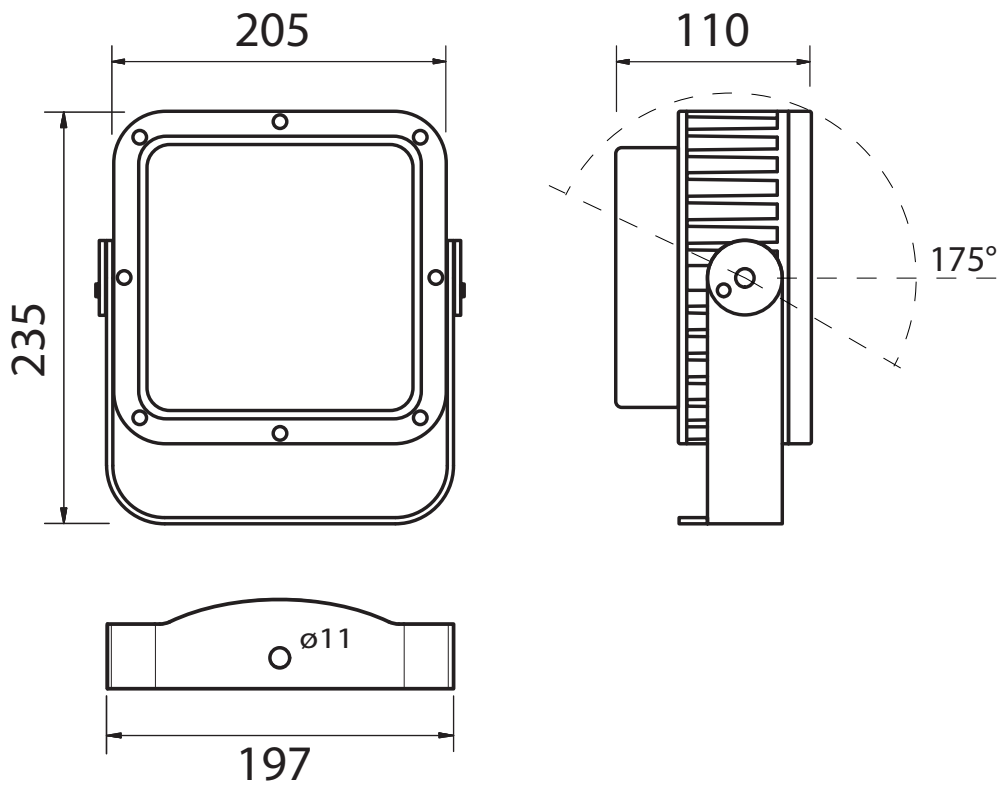

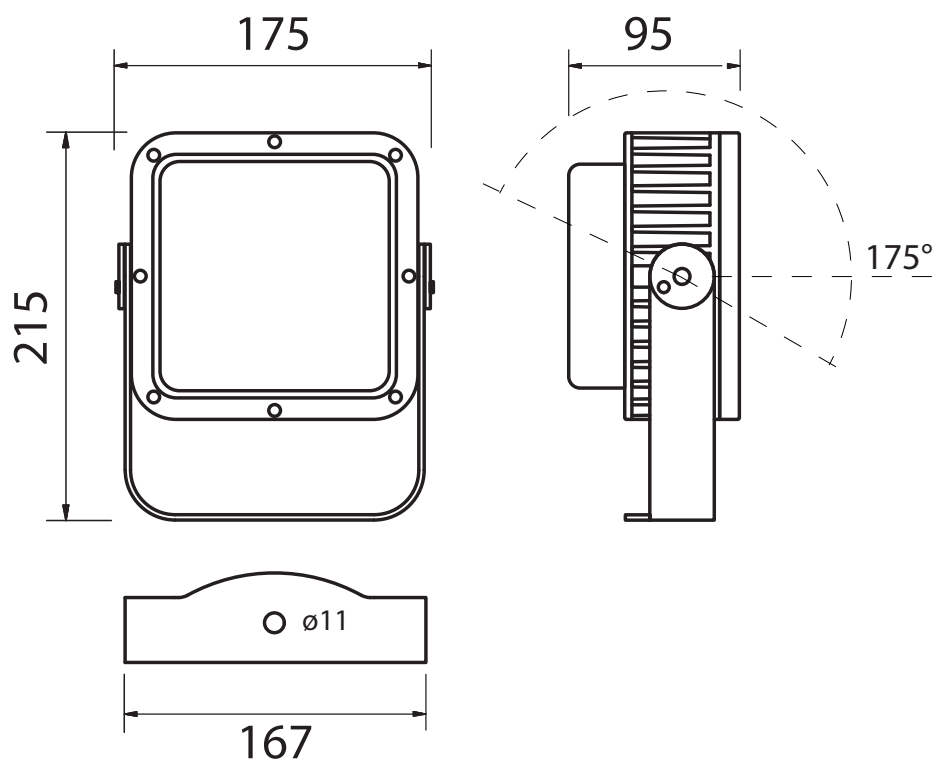

Dichiarazione CE di conformità

Declaration CE of conformity

La ditta: STUDIO DUE
The firm: Strada Poggino, 100
01100 VITERBO
ITALY

dichiara sotto la propria responsabilità che il prodotto:
declare under our sole responsibility that the product:

SMART17 IP67 series

code: 2001 (rgbwa)

è conforme alle norme: CE
is in conformity with the standard: CE

Low Voltage Directive: 2014/35/EU

EN 60529:1991 + A1:2000 + A2:2013
EN 62471:2008
EN 60598-1:2015
EN 60598-2-17:1989 + A2:1991

ECM Directive: 2014/30/EU

EN 61000-3-2:2014	EN 61000-4-2
EN 61000-3-3:2013	EN 61000-4-3
EN 61547:2009	EN 61000-4-4
EN 55103-2:2009	EN 61000-4-5
EN 55015:2013	EN 61000-4-6
EN 55103-1:2009 + A1:2012	EN 61000-4-11

e quindi ai requisiti essenziali delle Direttive:
and therefore according to essential requirement of Directives:

2004/108/EC – Electromagnetic compatibility
2006/95/EC – Low Voltage directive

Data di apposizione CE : 20
Date of CE marking : 20

VITERBO, 09/04/20

PAOLO SENSI
General Manager

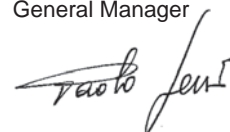

Dichiarazione CE di conformità Declaration CE of conformity

La ditta: STUDIO DUE
The firm: Strada Poggino, 100
01100 VITERBO
ITALY

dichiara sotto la propria responsabilità che il prodotto:
declare under our sole responsibility that the product:

SMART MAX30 IP67 series

code: 2050 (rgbwa)

è conforme alle norme: CE
is in conformity with the standard: CE

Low Voltage Directive: 2014/35/EU

EN 60529:1991 + A1:2000 + A2:2013
EN 62471:2008
EN 60598-1:2015
EN 60598-2-17:1989 + A2:1991

ECM Directive: 2014/30/EU

EN 61000-3-2:2014	EN 61000-4-2
EN 61000-3-3:2013	EN 61000-4-3
EN 61547:2009	EN 61000-4-4
EN 55103-2:2009	EN 61000-4-5
EN 55015:2013	EN 61000-4-6
EN 55103-1:2009 + A1:2012	EN 61000-4-11

e quindi ai requisiti essenziali delle Direttive:
and therefore according to essential requirement of Directives:

2004/108/EC – Electromagnetic compatibility
2006/95/EC – Low Voltage directive

Data di apposizione CE : 20
Date of CE marking :

VITERBO, 01/06/20

PAOLO SENSI
General Manager

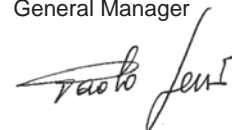

Warranty CARD

Studio Due®

Company name:

Mr./Mrs./Miss:

Address:

Tel. or E-mail :

Dealer:

travel at the customer's risk and peril, even if carriage paid.

SALE CONDITIONS

- 1) Price quoted are not inclusive of lamp and package.
Package charge is 2% on the net price for all the items.
These prices should be subject to possible variations for eventual rises of production costs or duties.
The goods travel at the expense, risk and peril of the customer.
Claims for possible damages during the freight, must be notified to the carrier.
Any claim must be notified within 8 days from the receipt of the goods.
The buyer is responsible of the right installation and use of the apparatus.
All the apparatuses are guaranteed for one year against defects of manufacture or materials.
Defects and breakages caused by wrong connection or use of the apparatuses are not subject to guarantee.
The lamp is excluded from the warranty.
For any dispute is competent the Tribunal of Viterbo.

CONDIZIONI DI VENDITA

- 1) I prezzi riportati sono esclusi di IVA, lampada ed imballaggio.
Il costo di imballaggio è del 2% sul prezzo netto per tutti gli articoli.
Detti prezzi possono essere soggetti a possibili variazioni per eventuali aumenti dei costi di produzione o imposte.
La merce viaggia a rischio e pericolo del committente, anche se in porto franco.
Reclami per possibili danni durante il trasporto, dovranno essere fatti esclusivamente al vettore.
Eventuali osservazioni sulle merci ricevute dovranno esserci notificate entro e non oltre 8 giorni dal ricevimento delle medesime. Sui ritardi dei pagamenti verrà conteggiato l'interesse commerciale.
L'acquirente si impegna a comunicare la propria esatta ragione sociale e partita IVA al momento dell'ordine e sotto la propria responsabilità di verificarla in fattura.
L'acquirente è responsabile della corretta installazione ed uso delle apparecchiature.
Tutte le apparecchiature godono della garanzia di un anno contro difetti di fabbricazione o di materiali, sono esclusi dalla garanzia danni derivanti da un cattivo uso o installazione delle apparecchiature.
Le lampade restano comunque escluse dalla garanzia.
Per ogni controversia è competente il Foro di Viterbo.

this page is intentionally left blank / questa pagina è stata lasciata intenzionalmente bianca

Studio Due[®]

emotion and creativity in light

Head Office: STUDIO DUE s.r.l. (I)

Str. Poggino, 100 - 01100 Viterbo (Italy)
tel. +39.0761.352520
fax +39.0761.352653
info@studiodue.com

STUDIO DUE (UK)

3 Encon Court Owl Close
Moulton Park Industrial Estate
Northampton England UK - NN3 6 HZ
tel. +44.1933.650.820
info@studiodue.co.uk

www.studiodue.com
for technical info
service@studiodue.com